

FINBIN[®]

COMMITTED TO HAPPINESS

SCANDINAVIAN DESIGN

LITTER BINS AND
RECYCLING BINS

SMART SOLUTIONS

WWW.FINBIN.FI

COMMITTED TO HAPPINESS

FINBIN®

CREATING CLEAN AND SUSTAINABLE ENVIRONMENTS TO ENSURE THE HAPPINESS OF PEOPLE AND THE WELL-BEING OF NATURE

THIS IS OUR MISSION AND THIS IS HOW WE WILL ACHIEVE IT:

HISTORY IS OUR ASSET

We have helped our customers develop urban environments since 1945 – in over 40 countries. This experience gives us valuable insight into durable solutions that are suitable for many different environments. Our accumulated competence is also useful for ensuring that our products serve all users, from maintenance staff to end-users.

SUSTAINABLE DEVELOPMENT IS OUR VALUE

We aim at sustainable resource use and energy efficiency in our operations. We say no to the consumption of disposables. We use metal as our primary raw material because it is the most widely recycled material in the world. We have developed a geothermal system to improve our energy efficiency. The system recovers the cooling energy from our production machines, which can be used for heating in the winter.



DESIGN IS OUR PASSION

We know that good design can help influence people's behaviour. An attractive product, for example, boosts recycling. Our Scandinavian design can be crystallised in the idea that *form follows function*. Our products are designed to be modern, functional, attractive and of a high quality.

QUALITY IS OUR FOUNDATION

High quality is our contribution to sustainable development. We only make products that endure time. People are the main factor in the creation of quality. Our professional staff take pride in creating unique experiences of quality. Our quality chain begins from customer service and an understanding of customer needs. It continues with our designers' skilfulness and drive to design timeless, durable products. Our quality process results in polished products in the hands of our accomplished and committed professionals. The right tools and materials are also part of quality.

TECHNOLOGY IS OUR FUTURE

We focus on technological development and the creation of new ideas to provide customers with increased added value and to build our future. Our history is an advantage in technological development. It helps us understand trends. Experience improves our ability to look into the future and understand our customers' future needs for products and services.

Nowadays, more than 50% of the population worldwide and lives in urban areas

80% of the population in Europe and North-America lives in urban areas

Well-designed, functional and clean urban spaces impact on quality of life and well-being

Environmental conditions affect directly human health and well-being

Our surroundings and their design affect what we do, how we do it and how we feel

Research shows that well-being can be strongly influenced by the built environment.

Better urban design -> Improved well-being -> benefits to the economy & individual

The cleanliness of streets shape people's behavior and increase caring for the environment

“Customer needs steer our design”

POWER FROM DESIGN

A smartly designed product is easy to use as well as easy to service and maintain. Well designed products can also be adapted to individual customer needs.

If you are looking for attractive articles that support your brand's value, the products created by our awarded design team are sure to answer your needs. Form and appearance often come second to the wish to guide end-users' behaviour, which is something that design can influence significantly.



BIM OBJECTS
and other 2D & 3D files
www.finbin.fi

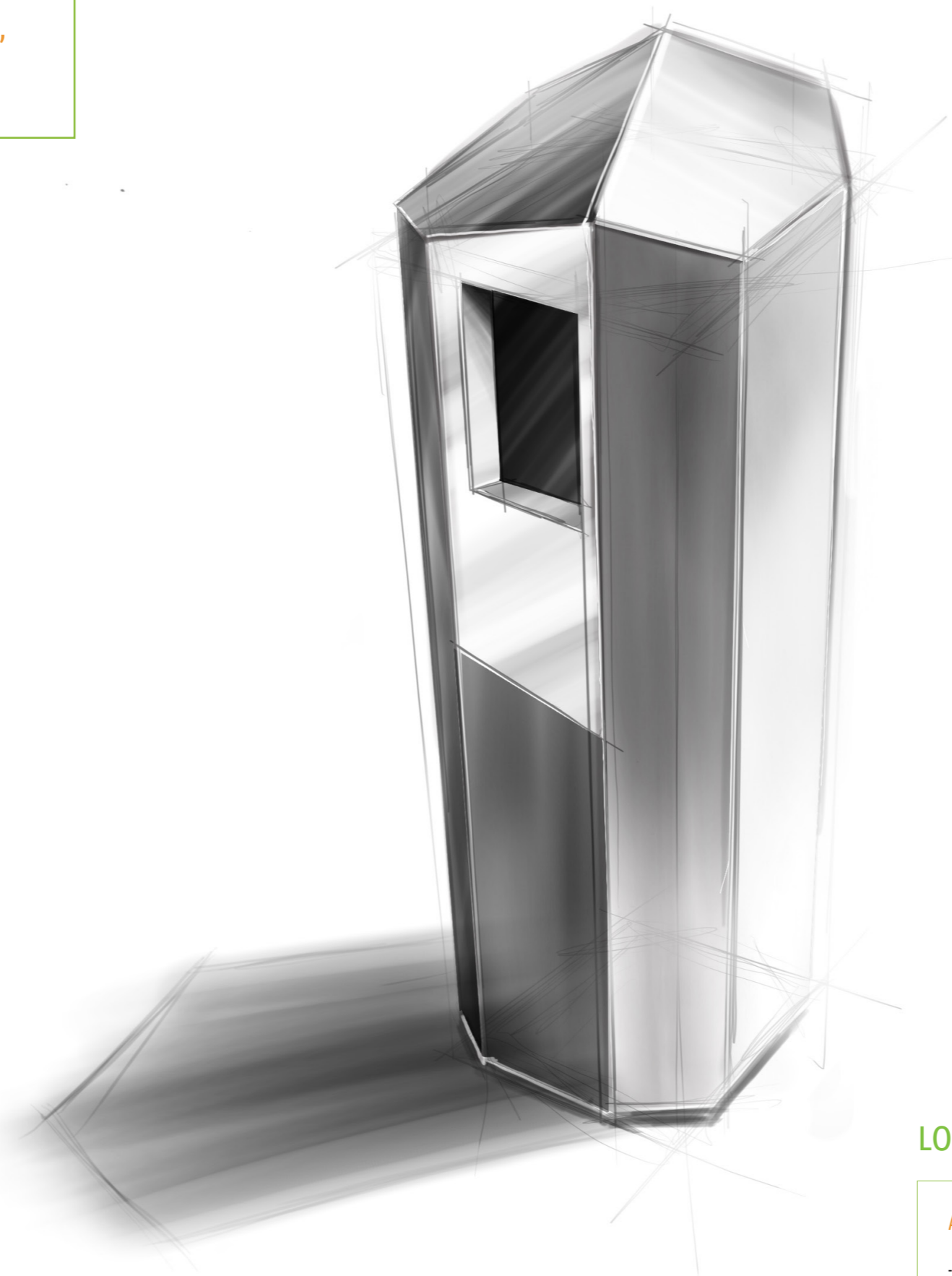

DURABILITY FROM MATERIALS

The high quality of Finbin® materials, supported by a timeless, practical design ensures a long service life for our products. High-quality materials are also necessary for the coupling of new design innovations and wear resistance.

We only use steel qualities that comply with international standards. We select the material based on the intended environment of use. Among other materials, we use galvanized steel, a unique material that considerably improves the corrosion resistance and paintability of products.

We employ modern production machines and techniques to achieve the best possible quality. Our own paint shop ensures flexible operations and good control of the surface treatment process.

MADE BY FINBIN®

Ease of use, durability, safety and beauty are aspects that are emphasised in the design of each Finbin® product. We ensure that any Finbin® product that you purchase from us is an original product, featuring recyclable materials.

LONGEST LIFE CYCLE, CORROBORATED BY TESTS

ADVANTAGES OF GALVANNEALED STEEL

- A stronger product with less material
- Excellent corrosion resistance
- Superior paintability

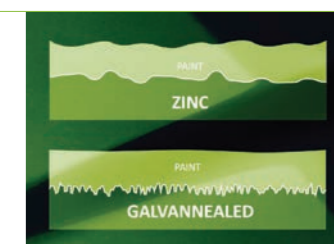



FINBIN®

LITTER AND RECYCLING BINS

ORIGINAL FINBIN QUALITY, FEATURING FUNCTIONAL DESIGN AND TOP QUALITY FROM FINLAND.

Deliveries to over 40 countries, including: City of Bilbao (Spain), English Garden (Munich, Germany), Dubai Metro (United Arab Emirates), Manchester Metrolink (United Kingdom), Frankfurt am Main (Germany), City of Amsterdam (the Netherlands), City of Amiens (France), Zurich Airport (Switzerland), Gull petrol stations (New Zealand), Airports of Moscow (Russia)

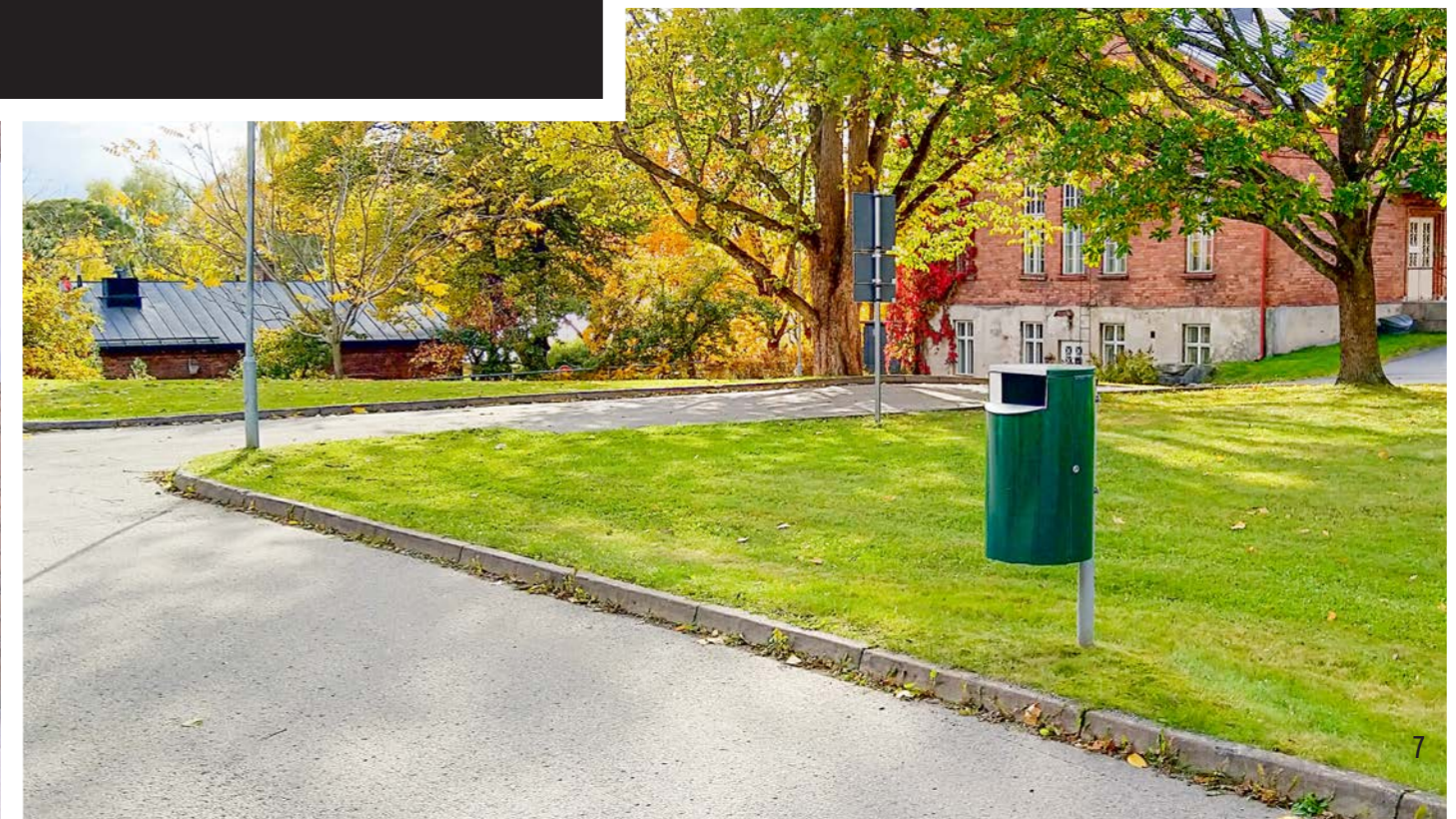
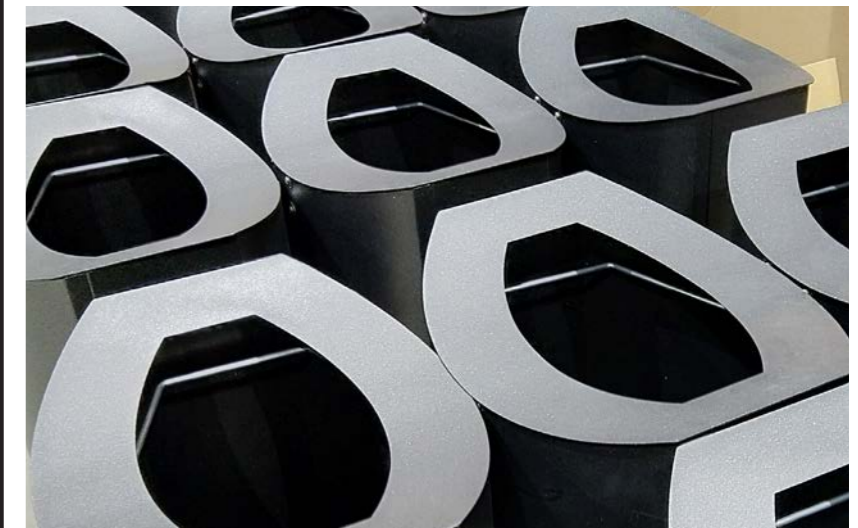

CITYSOLAR & CITYPACK

SOLAR-POWERED SMART LITTER BIN

FINBIN® CITYSOLAR IS A HIGH-CAPACITY SMART BIN FEATURING THE LATEST TECHNOLOGY.

CitySolar is well suited to locations where the amounts collected are large and maintenance needs to be efficient.

Customers using CitySolar have reported reductions of 80–95% in the frequency of bin emptying. This means that CitySolar needs to be emptied once in the same period in which a traditional litter bin needs to be emptied as many as 20 times.

The reduced frequency of emptying and the improved efficiency of maintenance mean that CitySolar offers considerable climate benefits.

CITYSOLAR FEATURES

CitySolar is a solar-powered smart bin, equipped with a compactor unit and fill-level measurement. The inner container is a 240-litre standard waste container. The light on the front panel indicates the fill level and need for emptying, helping to avoid unnecessary emptying activities. CitySolar can be linked to the FinbinCare maintenance management application, which sends automatic emptying requests by e-mail.

CITYPACK – SPACIOUS AND SMART WITHOUT COMPACTION

Finbin® CityPack is a sister product to CitySolar, which comes without the compactor unit. CityPack is ideal for streets and parks where large

litter bins are needed, but the capacity of the inner container is adequate for uncompacted waste or the collected material, such as newspapers, does not need to be compacted. The inner container of CityPack is a 240-litre standard litter bin.

CityPack can be equipped with a fill-level sensor and it can also be connected to the FinbinCare maintenance management application.

FINBIN® CARE MAINTENANCE MANAGEMENT APPLICATION

CitySolar and CityPack can be connected to the map-based FinbinCare application. The application indicates the location of bins

- The solar-powered waste compactor unit compacts waste material to save space
- Measures the fill level and sends a request for emptying straight to waste transportation
- Reduces frequency of emptying and transportation costs by as much as 95%
- Compliant with the map-based FinbinCare maintenance management application

as well as their fill level and sends automatic requests for emptying by e-mail. FinbinCare helps optimise maintenance measures and the frequency of emptying. Since it is a cloud-based service, it does not require any software installation.

FLEXIBLE DESIGN

The appearance of CitySolar and CityPack can be customised to the needs and environment. In addition to different colour schemes, it is possible to use various materials for the side panels. Images and shapes can also be printed on the sides.

SUITABILITY

The Finbin® CitySolar and Finbin® CityPack smart litter bins are easy to integrate into waste management logistics, since the 240-litre wheeled inner containers can be emptied straight into waste collection vehicles or other vehicles fitted with a container tipping device. This eliminates the need for manual emptying.

CitySolar and CityPack are well suited to locations where the amounts of waste collected are large and the emptying frequency as well as maintenance need to be optimised and enhanced. The bins provide a more efficient waste management solution for urban streets, parks and squares as well as indoor facilities, such as venues, educational institutions, shopping malls and convention centres.

CITYSOLAR IN BRIEF

- Patented technology for mechanics and control
- The largest capacity on the market: up to 1,200–1,700 litres
- The most efficient compaction mechanics. Maximum compaction force of 600 kg
- Correctly timed emptying thanks to patented fill-level measurement
- FinbinCare cloud service
- Outdoor/indoor versions
- 240-litre and 120-litre versions



Compaction



Less frequent emptying



Solar energy



Cloud service



ORIGINAL DESIGN YRJÖ OJANEN



DIMENSIONS



CAPACITY



APERTURE



WEIGHT



MATERIAL



THICKNESS

CITYSOLAR outdoor use, solar-powered
CITYSOLAR indoor use, mains-powered

1440*750*890 mm

standard 240-litre
2-wheeled plastic
container DIN EN 840

380*200 mm

150 kg

Aluminium, powder-coated galvanised steel, stainless steel

various

CITYPACK (without hatch)
single-sided
double-sided

1440*750*890 mm

standard 240-litre
2-wheeled plastic
container DIN EN 840

380*200 mm

72 kg

Aluminium, powder-coated galvanised steel, stainless steel

various



STANDARD COLOURS
other RAL colours upon request



Finbin Black 1945
(textured)



ACCESSORIES

Stickers with recycling instructions

Concrete slab

Adjustable legs

Combi ashtray

Recycling rack

Aperture for bottle recycling (CityPack)

We reserve all rights to changes.

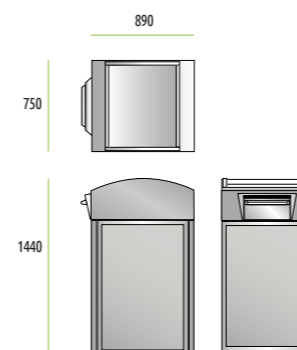

REFERENCES

- City of Oslo (Norway)
- City of Solna (Sweden)
- City of Nora (Sweden)
- City of Helsinki (Finland)
- City of Hanko (Finland)
- City of Porvoo (Finland)
- Korkeasaari Zoo (Finland)

User-friendly, modern solution for the maintenance of furniture and equipment.

FINBIN® CARE

MORE EFFICIENT FURNITURE, EQUIPMENT AND WASTE MANAGEMENT

The map-based Finbin@Care application makes it easy to manage large volumes of furniture and equipment. Making use of location data, the application displays park benches, litter bins and other items clearly on the map.

Finbin@Care is a cloud-based service, which means it can be accessed online with smart devices. The service does not require any software installation.

Finbin@Care allows service requests and failure notifications to be sent from a smartphone to the person in charge of maintenance. It identifies furniture and equipment based on the smartphone readable NFC/QR tags attached to them. The location of furniture and equipment registered in the system is always known.

Furniture and equipment can also be assigned

to specific service areas so that the service requests and notifications are e-mailed directly to the appropriate person. The application can also be used to schedule periodic maintenance.

FEATURES

Finbin@Care is extremely easy to use. It displays the basic information of furniture and equipment, their location on the map and any relevant notifications. It also enables the scheduling of maintenance activities. If a piece of furniture or equipment is moved to another location or into storage, the transfer and the new location can be easily recorded in the system.

Finbin@Care can also be used to include end-users in waste management. You can choose to allow end-users to submit a request for emptying litter bins through their smartphone.



SUITABILITY

Finbin@Care is a user-friendly system for the management of urban furniture and equipment as well as for waste management and is well suited to, for example, cities or real-estate companies. The map-based application, accessible on smartphones and other smart devices, is a tool for managing the location and maintenance of urban furniture and equipment, including tasks such as emptying waste containers and servicing outdoor furniture.

Finbin@Care helps maintain and locate on the map a large volume of furniture and equipment,

such as outdoor benches, litter bins, light poles, bicycle racks, shelters and playground equipment. If required, end-users can be allowed to make a request for furniture repair or litter bin emptying using their own smartphones.

FINBIN@CARE IS COMPATIBLE WITH THE FINBIN SMART LITTER BINS.

CitySolar and CityPack can be connected to the map-based Finbin@Care application. The application indicates the location of bins as well as their fill level and sends automatic requests for emptying by e-mail.

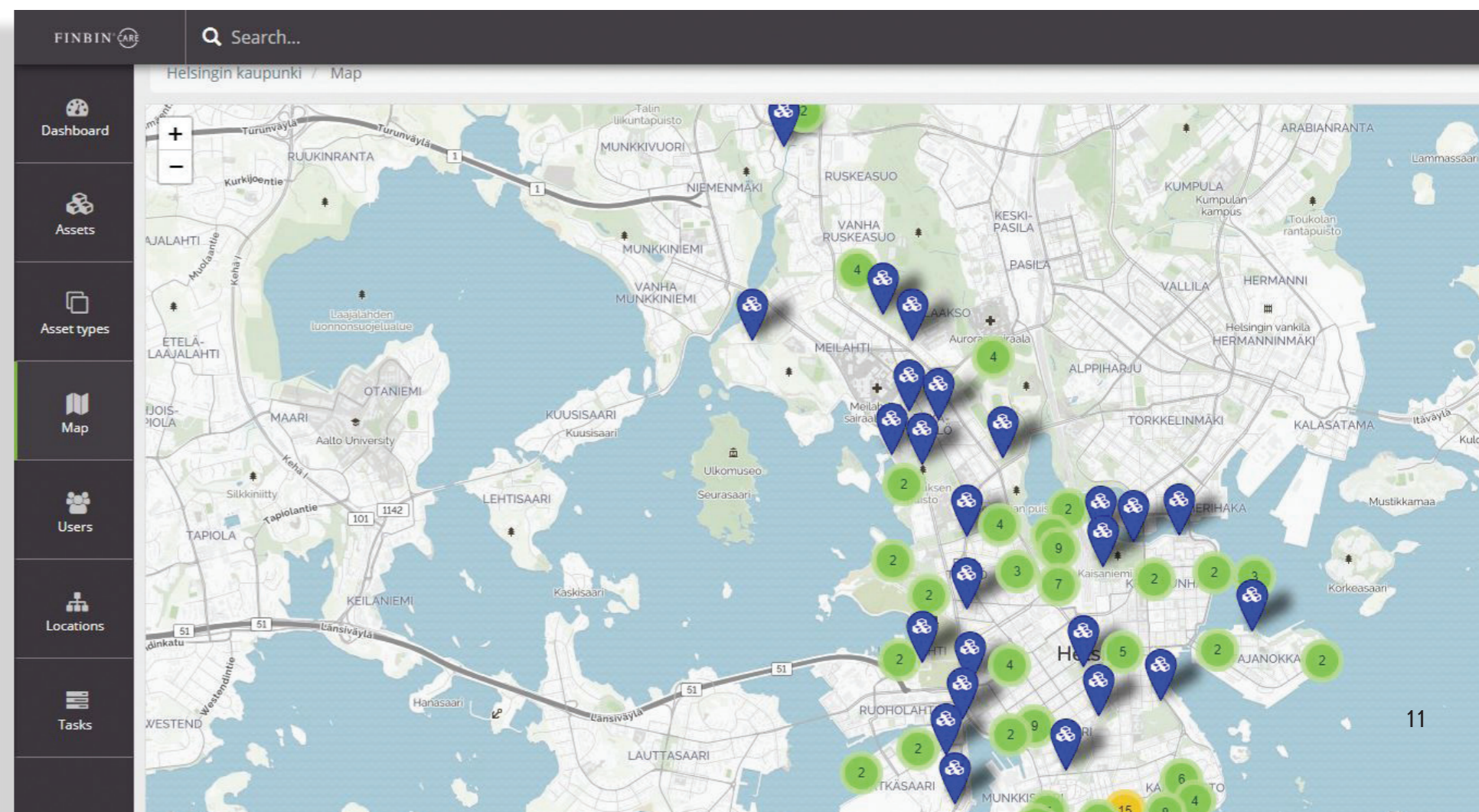

NOVUS

The diverse fixtures and colour schemes make Novus an excellent choice for various outdoor and indoor uses.

SUITABILITY

Novus is a stylish, durable and practical litter bin that is suitable for use in streets and parks as well as in various indoor facilities, such as shopping malls, halls, government agencies, office spaces and reception areas. Novus can be converted into a double-sided

litter bin and can accommodate an ashtray or a recycling rack for beverage cans.

FEATURES

Novus comes in four sizes. The three largest models are also available as double-sided bins. Novus features a large aperture, which makes it more comfortable to use. The Novus 80, 120 and 200 models can also be equipped with a side-mounted ashtray. Combi ashtrays and recycling racks for

bottles and cans are available as accessories for all models.

Novus features a durable frame, a hinged, lockable door and a galvanised liner. The inclined, convex lid helps remove water and snow off the bin and prevents users from leaving rubbish on top of the bin.

Finbin® Novus is a modern bin that combines attractiveness and practicality.

ORIGINAL DESIGN YRJÖ OJANEN	DIMENSIONS	CAPACITY	APERTURE	WEIGHT	MATERIAL	THICKNESS
NOVUS 50	660*360 mm	50 l Galvanized liner 35 l	290*140 mm	20 kg	galvannealed steel and sst EN1.4301	2 mm
NOVUS 80 NOVUS 80 double-sided	920*360 mm 930*360 mm	80 l Galvanized liner 50 l	290*140 mm	25 kg	galvannealed steel and sst EN1.4301	2 mm
NOVUS 120 NOVUS 120 double-sided	1050*400 mm 1050*400 mm	120 l Galvanized liner 80 l	330*150 mm	32 kg	galvannealed steel and sst EN1.4301	2 mm
NOVUS 200 NOVUS 200 double-sided	1150*550 mm 1170*550 mm	200 l Galvanized liner 150 l	480*170 mm	58 kg	galvannealed steel and sst EN1.4301	2 mm
NOVUS COMBI ashtray	560*150 mm	4,5 l	75*25 mm	4 kg	galvannealed steel and sst EN1.4301	1.25 mm

STANDARD COLOURS other RAL colours upon request	stainless steel	Finbin Black 1945 (textured)	RAL 6005	RAL 7024	RAL 9005	RAL 9006	DB703 (textured)
--	-----------------	------------------------------	----------	----------	----------	----------	------------------

ACCESSORIES also see pages 18-19	Metal and concrete bases	Post and wall mounts	In-ground concrete base and post	Integrated ashtray	Combi ashtray	Recycling rack
-------------------------------------	--------------------------	----------------------	----------------------------------	--------------------	---------------	----------------

We reserve all rights to changes.

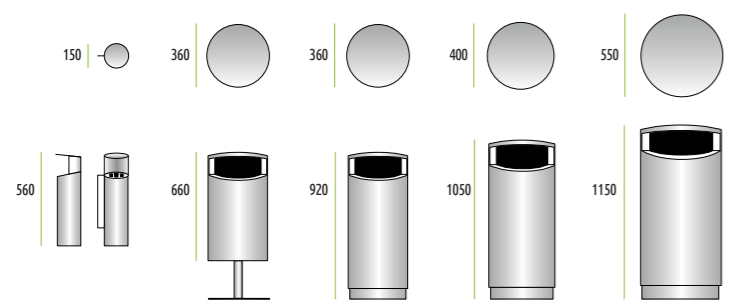

REFERENCES

- Tallinn main railway station (Estonia)
- City of Helsinki (Finland)
- Stockholm metropolitan area (Sweden)





Modern style

UNIQUE

Finbin® Unique is the right choice for environments where style and detail come into play. The timeless design of the Unique Series communicates high quality.

The stylish exterior conceals many ingenious details that make Unique bins easy and safe to use and maintain. The carefully designed shape and size of the aperture protect the contents from the rain, birds and vandalism and keep them out of sight of passers-by. Stainless steel, the standard material of Unique products, gives the recycling bins a sophisticated

look as well as excellent durability. Unique bins are made of stainless steel and can be painted to order.

FEATURES







Unique bins have a lockable, side-hinged front door that is safe and easy to open and close. The steel inner container is easy to empty. The rounded shape and double surface treatment improve vandal and weather resistance.









Unique Series litter bins can be equipped with a recycling aperture for the selective

collection of material, such as paper or PET bottles.

SUITABILITY

Finbin® Unique is well suited for use as a litter or recycling bin in highly demanding environments. Representing high quality and superior style, Unique is ideal for use in government and municipal agencies, shopping malls, reception facilities, showrooms, airports and cruise ships.

	 DIMENSIONS	 CAPACITY	 APERTURE	 WEIGHT	 MATERIAL	 THICKNESS
UNIQUE 100	1050*400 mm	Galvanized liner 56 l	260*140 mm	35 kg	sst EN1.4301	2 mm
UNIQUE 140	1090*460 mm	Galvanized liner 91 l	300*140 mm	41 kg	sst EN1.4301	2 mm

 STANDARD COLOURS other RAL colours upon request	 stainless steel	 Finbin Black 1945 (textured)	 RAL 6005	 RAL 7024	 RAL 9005	 RAL 9006	 DB703 (textured)
 ACCESSORIES also see pages 18-19	Metal and concrete bases	Post and wall mounts					

We reserve all rights to changes.

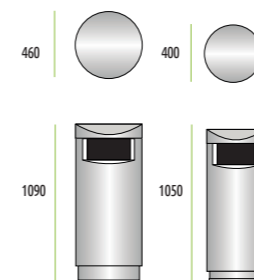

REFERENCES

- Zurich Airport (Switzerland)
- Pluscity shopping centre (Austria)
- Airports of Moscow (Russia)
- Gull petrol stations (New Zealand)
- Frankfurt am Main (Germany)
- City of St. Moritz (Switzerland)

Award-winning design

ELLIPSE

It has been called the Rolls-Royce of litter bins. Designed by Max Bruun, the prize-winning, innovative design of Finbin® Ellipse, has secured this litter bin a home in many well-known locations, such as the Dubai Metro and the City of Amsterdam in the Netherlands.

The slim and sleek Ellipse fits into small spaces and stays clean thanks to its curved top. The structure of the precisely dimensioned Ellipse bins is durable and stable, making the bins easy to use and maintain. The design keeps

birds and rain out of the bin.

Ellipse bins are made of high-quality stainless steel and galvanised powder-coated steel.

FEATURES

The hinged door opens sideways, unfastening the lid to facilitate maintenance. Ellipse 60 and 100 can be equipped with an ashtray placed on top of the bin for easy access. The ash container is made of stainless steel and can be emptied by opening the front door and unhooking the container. The Ellipse

models accommodate most Finbin® fixtures.

SUITABILITY

Awarded for its design, Finbin® Ellipse is a stylish and durable litter bin, featuring an integrated ashtray. Ellipse bins are the choice of various international facilities that appreciate creative details and high quality, such as hotels, metro stations, reception facilities, airports, government agencies, venues, railway stations and business premises.

ORIGINAL DESIGN MAX BRUUN	DIMENSIONS	CAPACITY	APERTURE	WEIGHT	MATERIAL	THICKNESS
ELLIPSE 60	700*450*350 mm	Galvanized liner 40 l	300*140 mm	20 kg	galvannealed steel and sst EN1.4301	2 mm
ELLIPSE 100	960*450*350 mm	Galvanized liner 56 l	300*140 mm	31 kg	galvannealed steel and sst EN1.4301	2 mm

STANDARD COLOURS other RAL colours upon request	stainless steel	Finbin Black 1945 (textured)	RAL 6005	RAL 7024	RAL 9005	RAL 9006	DB703 (textured)
ACCESSORIES also see pages 18-19	Metal bases	Post and wall mounts	In-ground concrete base and post	Integrated ashtray			

We reserve all rights to changes.

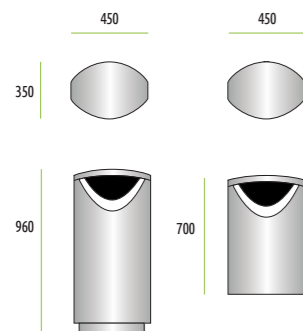

REFERENCES

- Dubai Metro (United Arab Emirates)
- Manchester Metrolink (United Kingdom)
- City of Amsterdam (the Netherlands)
- City of Amiens (France)



City® embodies Scandinavian functional design.

CITY®

Embodying Scandinavian functional design, Finbin® City® has been conquering the world since the 1990s.

The product design of City® is based on detailed surveys and tests. The design team, led by Hannu Kähönen, was tasked with creating a litter bin that could be emptied as easily, safely and efficiently as possible. Another goal for design was to develop a sturdy product that would resist vandalism and endure long-term mechanical strain.

Originally designed for the City of Helsinki, City® was a classic from the start. City® and its latest product versions are familiar sights around the world.

The timeless design of Finbin® City® is well suited to many environments. The eye-catching City® Castle exemplifies how the design of the City Series has evolved over time. Castle has been designed to meet the same functional goals as the original City bins.

The City® bins are made of high-quality stainless steel and galvanised powder-coated steel.

FEATURES

The City® Series offers a wide range of sizes, fixtures and colours. The hinged front door can be locked. The City® bin's galvanized steel inner container is easy and safe to empty. Except for Castle, all City® bins can be equipped with an integrated ashtray or a side ashtray as well as with a recycling rack for bottles and cans.

The carefully thought through design of the City Series keeps birds and rain out of the bins. The City bins can be equipped with a bird guard and hygiene hatch.

SUITABILITY

Finbin® City®, our best known litter bin, is an excellent example of Scandinavian functional design. The City® Series provides a range of stylish and extremely durable litter bins that are easy to empty efficiently. The versatile City® Series comes with numerous accessories. City® bins can be found in the streets, parks, airports and indoor facilities of various urban environments worldwide.



City® Castle is designed to prevent graffiti and stains and reduce maintenance costs.

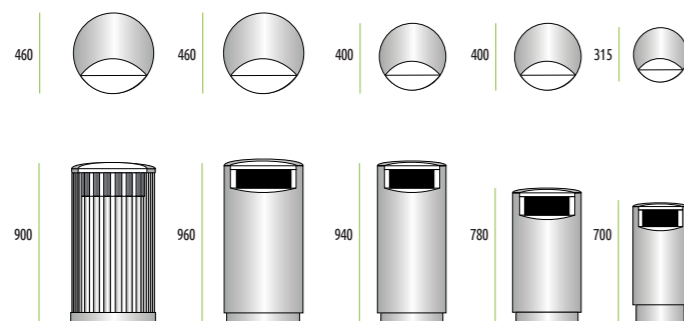

REFERENCES

- City of Bilbao (Spain)
- City of Malmö (Sweden)
- English Garden (Munich)
- City of Helsinki (Finland)

ORIGINAL DESIGN HANNU KÄHÖNEN	DIMENSIONS	CAPACITY	APERTURE	WEIGHT	MATERIAL	THICKNESS
CITY 30	580*315 mm	Galvanized liner 22 l / with integrated ashtray 16 l	200*100 mm	13-14.5 kg	galvannealed steel and sst EN1.4301	2 mm
CITY 60	700*400 mm	Galvanized liner 50 l / with integrated ashtray 35 l	260*120 mm	26.5-28 kg	galvannealed steel and sst EN1.4301	2 mm
CITY 100	940*400 mm	Galvanized liner 62 l / with integrated ashtray 47 l	260*120 mm	33-34.5 kg	galvannealed steel and sst EN1.4301	2 mm
CITY 140	960*460 mm	Galvanized liner 91 l / with integrated ashtray 80 l	300*120 mm	38.5-40 kg	galvannealed steel and sst EN1.4301	2 mm
CITY CASTLE (without sst option)	900*460 mm	72 l	300*120 mm	35 kg	galvannealed steel and sst EN1.4301	1.5 / 5 mm
COMBI ASHTRAY	470*125 mm	4.5 l	25*25 mm	4.5 kg	sst EN1.4301	1.25 / 2 mm

STANDARD COLOURS other RAL colours upon request	stainless steel	Finbin Black 1945 (textured)	RAL 6005	RAL 7024	RAL 9005	RAL 9006	DB703 (textured)	
ACCESSORIES also see pages 18-19	Metal and concrete bases	Post and wall mounts	In-ground concrete base and post	Integrated ashtray	Combi ashtray	Recycling rack	Bird guard / dog waste chute	Fireproof hatch

We reserve all rights to changes.

CUBIO



Cubio is our stylish new addition to the Finbin® family. Cubio is especially designed for modern architecture. Sharp edges and intriguing looks tempt to recycle.

“Form follows function” has been one of our main themes during the design process of Cubio. Every shape is deliberate and supportive to the functionality of the bin. It attracts to use it. Versatile accessories guarantee the suitability of the bin for different kind of environments and preferences.

FEATURES

120 liter capacity ensures sufficient volume for public environments. Cubio is made of high-grade powder coated steel. Cubio recycling bin is also available as a two-sided model and there are also options for a hatch and an integrated ashtray. Front door is hinged and it has keyless magnet locking. Mounting options for Cubio are free standing and bolt mounting.

SUITABILITY

Cubio suits perfectly to urban environments, outdoor or indoor. It can be described in three words: design, useability and ease of maintenance. Cubio can be used as a single litter bin or you can combine bins together to make the perfect indoor or outdoor sorting station. Clear colour-coded sorting instruction stickers guide users to sort the material accordingly. Main theme during the product development process was: “Recycling everywhere!”

ACCESSORIES



ORIGINAL DESIGN HENRI SYDÄNHEIMO	DIMENSIONS	CAPACITY	APERTURE	WEIGHT	MATERIAL	THICKNESS	
CUBIO 1- & 2-sided models	1210*420*440 mm	120l Galvanized liner 60 l	125*210 mm	45 kg	Galvannealed steel	2 mm	
STANDARD COLOURS other RAL colours upon request	RAL 9010	Finbin Black 1945 (textured)	RAL 6005	RAL 7024	RAL 9005	RAL 9006	DB703 (textured)
ACCESSORIES also see pages 18-19	Metal and concrete bases	Post and wall mounts	Bird guard/ dog waste chute	Triangular key lock	Galvanised liner or bag frame	Stickers with recycling instructions	

We reserve all rights to changes.



Hatch



Integrated ashtray



Lock

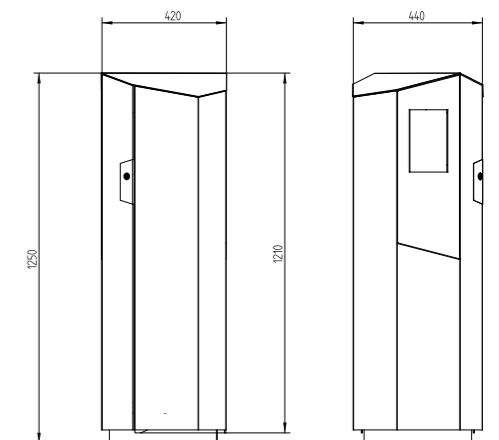

Dimensions with a steel base

MODUL SERIES

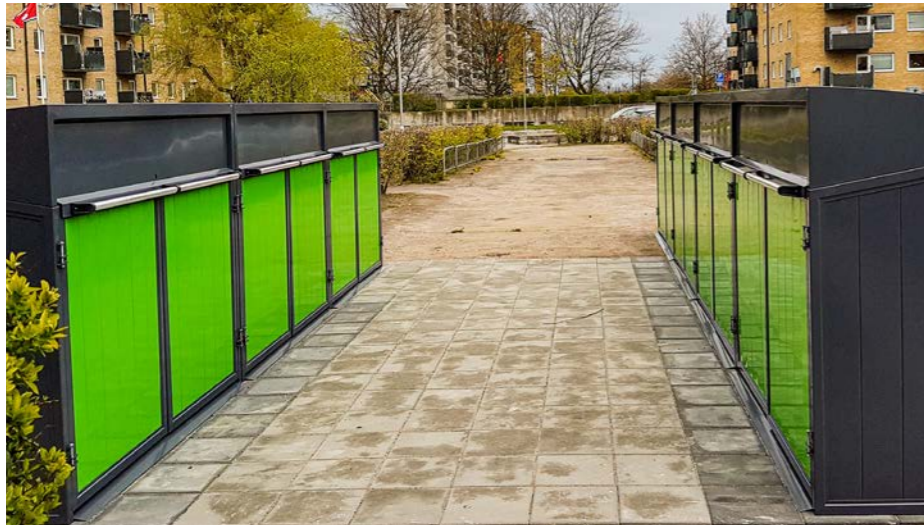

MODUL BIN SHELTER is a flexible and versatile solution to your waste collection point's needs. It can be used with all the commonly known waste bin models.

Bin shelters can be connected to each other from the ends to form a unified combination of several bin shelters. Modul adjusts to different environments perfectly. Different panel options are available for double doors

and end elements (excluding the Maxi model that has the option only for the double doors).

Standard colour is RAL7024 but other RAL colours and our own FinBin Black -colour are available as an option.

The loading aperture is equipped with hinged, gas spring-supported loading hatch. The loading hatch can be equipped with 2-cylinder

lock housing. The client can then serialize the locks for the real estate's keys.

We have also taken into account the fire safety of waste collection points and Modul 1 model is also available as a fire-isolated version. The inside of the bin shelter is lined with A1 category non-combustible fireproof panels.

	DIMENSIONS	CAPACITY	APERTURE	WEIGHT	MATERIAL	THICKNESS
MODUL 1 MODUL 1 FIRE-ISOLATED	1500*1550*1000 mm	1*660 or 2*140/240 or 140/240*360 l stand. bins	1420*360 mm	85 kg 145 kg	Marine-grade aluminum and galvanized steel	1,5/2 mm
MODUL XL	1980*1550*1000 mm	3*140/240 or 1*140/240*360 l stand. bins etc.	1900*360 mm	100 kg	Marine-grade aluminum and galvanized steel	1,5/2 mm
MODUL MAXI MODUL MAXI FIRE-ISOLATED	1900*1660*1480 mm	2*660 l	1820*460 mm	145 kg 230 kg	Marine-grade aluminum and galvanized steel	1,5/2 mm

STANDARD COLOURS
other RAL colours upon request

RAL 7024

ACCESSORIES

2-cylinder lock housing (standard with the fireproof models)

Adjustment feet

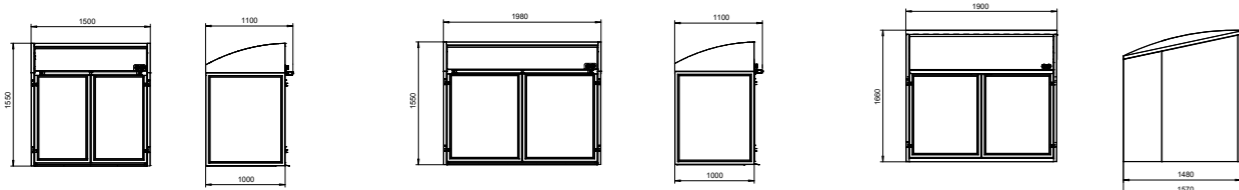

We reserve all rights to changes.

ASHTRAYS



ASHLEY ASSTRAY

The inclined top of elegant Ashley ashtray makes it easy to stub the cigarette and drop it into the aperture. It also prevents snow from gathering and water from dripping into the unit. The small aperture and the tight construction smother burning cigarette ends. Emptying through a lockable bottom flap. Ashley's material is stainless steel. Installation method is wallmounting.

COMBI ASSTRAY

Get a better look for your environment with Combi ashtray from FINBIN®. Street or park environment or a real-estate's yard, you can find a suitable solution from our product line because of our broad selection of standard colours. Combi's material is stainless steel. Installation method is wall or post mounting with post mounts.

CITY@ HOTBIN

City@ Hotbin is the cigarette disposal unit for heavily populated surroundings. It can be used together with the other City@ series litter bins. All FinBin® City 30 fastening alternatives can be used with City Hotbin.

	DIMENSIONS	CAPACITY	APERTURE	WEIGHT	MATERIAL	THICKNESS
ASHLEY	600*85 mm	3,5l	30 mm	2 kg	sst EN1.4301	1,5 mm
COMBI	490*ø125 mm	4,5l	260*120 mm	2,6 kg	sst EN1.4301	1,5/2 mm
CITY HOTBIN	580*315 mm	Galvanized liner 22l	200*100 mm	14 kg	galvanized steel and sst EN1.4301	2 mm

STANDARD COLOURS
other RAL colours upon request

stainless steel (only option for the Ashley)

Finbin Black 1945 (textured)

RAL 6005

RAL 7024

RAL 9005

RAL 9006

DB703 (textured)

ACCESSORIES
also see pages 18-19

Post mounts for the COMBI ashtray

CITY HOTBIN fixtures at pages 18-19

We reserve all rights to changes.

FINBIN® FIXTURES AND ACCESSORIES



Metal and concrete bases

Ground post

Wall mount

Plate post



	METAL BASES						CONCRETE BASES				WALL MOUNTS		POSTS		POST MOUNTS
Model	City 30 Metal base	Novus 50/80 Metal base	60/100 -120 Metal base	140-160 Metal base	Ellipse 60 Metal base	Ellipse 100 Metal base	City 30/Novus 50 Concrete for ground post	Novus 50/80 Concrete base stainless steel surface	60/100 -120 Concrete base stainless steel surface	140-200 Concrete base stainless steel surface	100-140 Wall mount	30-80 Wall mount	30-80 Ground post	30-80 Plate post	30-80 Post mounts
Dimensions	Ø 280 x h. 127 mm	Ø 340 x h. 100 mm	Ø 365 x h. 100 mm	Ø 430 x h. 100 mm	w. 445 x h. 253 x d. 330 mm	w. 445 x h. 86 x d. 330 mm	Ø 280 x h. 127 mm	Ø 340 x h. 100 mm	Ø 365 x h. 82 mm	Ø 530 x h. 100 mm	w. 169 x h. 790 x d. 26.6 mm	w. 169 x h. 365 x d. 27 mm	Ø 60 x h. 1200 mm	Ø 60/ 450 x h. 900 mm	*4
City Series	30/HOTBIN n						n					n	n	n	n
	60		n				n		n			n	n	n	n
	100		n								n				
	140			n						n					
Ellipse Series						n	n					n	n	n	n
	100										n				
Unique Series			n								n				
	100										n				
	140			n						n					
Novus Series		n					n	n				n	n	n	n
	50											n	n	n	n
	80	n					n	n				n	n	n	n
	120		n						n						
	160				n					n					
	200				*1					n					

We reserve all rights to changes.

*1 integrated metal base

*2 h. 47" *3 h. 67"

*4
 Ø 60.3 mm
 Ø 75-85 mm
 Ø 108-120 mm
 Ø 130-150 mm
 Ø 155-168 mm
 Ø 203-219 mm
 Ø 315 mm

ACCESSORIES CITY® Series 30/60/100/140



Hygiene hatch/Dog chute



Bird guard

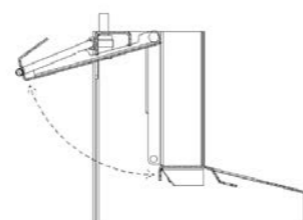

Fireproof

COMBI ashtray and RECYCLING RACK for CITY® and NOVUS models



Combi ashtray



Recycling rack



The most popular Finbin® recycling bin

BERMUDA

Finbin® Bermuda combines elegant design with advanced safety aspects – such as a self-extinguishing structure. Delivered to over 30 countries, the Bermuda products are used as both recycling bins and stand-alone litter bins. Bermuda bins are made of high-quality stainless steel and galvanised powder-coated steel. We deliver Bermuda bins in stainless steel or galvanised powder coated steel.

FEATURES

Our wide Bermuda range offers alternatives from stand-alone litter bins to the Quad recycling bin with four apertures. The largest stand-alone in, Jumbo, has a capacity of 200 litres.

Bermuda bins can be equipped with coloured stickers to help users recycle different types of waste. A lid with a round aperture is available for bottles and cans.

SUITABILITY

The innovative, stylish design of FinBin® Bermuda makes the bin a popular option for recycling in passenger terminals, hotels, shops, shopping centres and reception facilities around the world. Bermuda litter bins are particularly well suited for indoor use. They can be found in, for example, corporate offices and headquarters, various exhibition facilities, airports, government agencies and campuses. Bermuda is a safe litter bin thanks to its self-extinguishing structure.

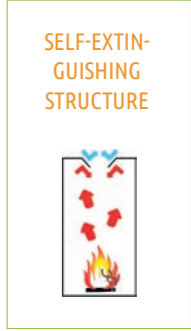

ORIGINAL DESIGN YRJÖ OJANEN	DIMENSIONS	CAPACITY	APERTURE	WEIGHT	MATERIAL	THICKNESS
BERMUDA 80	400*400*760 mm	80 l, bag frame for 150 l refuse bag	200*200 mm	13 kg	powder-coated galvanised steel and sst EN1.4016	1.25 mm
BERMUDA DOUBLE	860*450*770 mm	2*100 l, bag frame for 150 l refuse bag	200*200 mm 210*100 mm	29 kg	powder-coated galvanised steel and sst EN1.4016	1.25 mm
BERMUDA TRIPLE	1160*450*770 mm	3*100 l, bag frame for 150 l refuse bag	200*200 mm 210*100 mm	53 kg	powder-coated galvanised steel and sst EN1.4016	1.25 mm
BERMUDA QUAD	1560*450*770 mm	4*100 l, bag frame for 150 l refuse bag	200*200 mm 210*100 mm	66 kg	powder-coated galvanised steel and sst EN1.4016	1.25 mm
BERMUDA JUMBO	560*560*880 mm	200 l, bag frame for 200 l refuse bag	300*300 mm	21 kg	powder-coated galvanised steel and sst EN1.4016	1.25 mm

STANDARD COLOURS other RAL colours upon request	stainless steel	Finbin Black 1945 (textured)
ACCESSORIES	Stickers with recycling instructions	Apertures for bottles

We reserve all rights to changes.

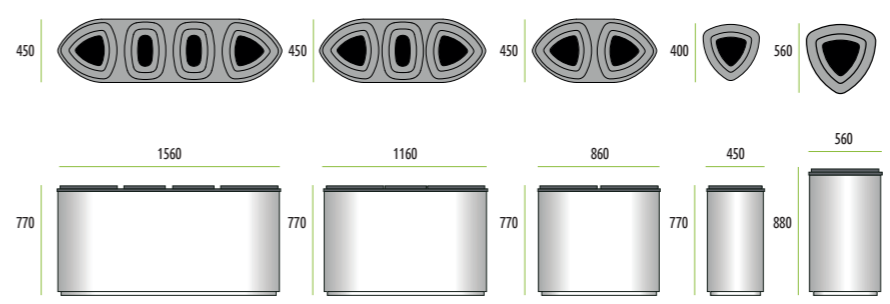

- REFERENCES**
- International airports
- Washington DC (USA)
 - Islamabad (Pakistan)
 - Astana (Kazakhstan)
 - Luton (United Kingdom)
 - Helsinki (Finland)

EDGE

The Finbin® Edge Series stands for timeless design. Thanks to their modularity, individual Edge bins can be combined to achieve the required recycling station. A recycling station composed of Edge bins can be flexibly adapted, should your needs change later. Edge bins are available in several colours.

The models are made of high-quality stainless steel or galvanised powder-coated steel.

FEATURES

Edge bins have a capacity of 100 litres. They feature a hinged lid and a pivoting bag holder. Edge bins are supplied in various colours and with different recycling apertures. The bins can be linked with connectors. Different types of recycling stickers are also available. The standard colour scheme for Edge bins consists of a stainless steel frame (EN 1.4016) and a black lid and base. We also offer a powder-coated option, which is fully black.

SUITABILITY

The subtle, rectangular, streamlined design makes Edge well suited for office facilities, public spaces, hospitals, campuses, sports halls, exhibition facilities and convention centres, with variable recycling needs. Edge bins are also suitable for environments of a more classic style, such as museums. The lid is shaped to provide a self-extinguishing feature.

 ORIGINAL DESIGN HENRI SYDÄNHEIMO	 DIMENSIONS	 CAPACITY	 APERTURE	 WEIGHT	 MATERIAL	 THICKNESS
EDGE	380*380*780 mm	100 l, bag frame for 100-150 l refuse bag	160*160 mm	15 kg	powder-coated galvanised steel and sst EN1.4016	1.25 mm
 STANDARD COLOURS other RAL colours upon request	 stainless steel	 Finbin Black 1945 (textured)				
 ACCESSORIES	 Stickers with recycling instructions		 Various recycling apertures			

We reserve all rights to changes.

Simple elegance

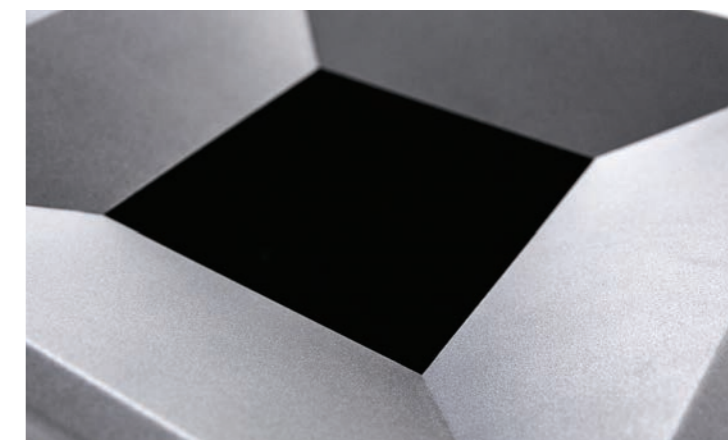

CONICAL LID,
PROVIDING SELF-
EXTINGUISHING
FEATURE



REFERENCES

- Tallinn Railway Station (Estonia)
- Tallink-Silja Ferries (Estonia)
- Cancer institute Verbeeten (the Netherlands)
- PLC Mega shopping centre (Lithuania)



The design of Wave symbolises motion and encourages recycling.

WAVE

The Wave Series has been designed for indoor recycling in public facilities. Wave is available in models with two or three recycling units. The smaller version of Wave can be used as a stand-alone litter in. The bins are made of high-quality stainless steel and galvanised powder-coated steel.

FEATURES

Wave bins are equipped with a hinged lid to make emptying and maintenance as easy as possible. The bins also feature pivoting bag frames. Different types of recycling stickers available to help end

users deposit waste in the right unit. The standard colour scheme is either powder-coated metallic black (body and top) or a stainless steel body with a metallic black top.

SUITABILITY

The Finbin® Wave Series is a stylish recycling station that is well suited to many different environments, such as shopping centres, airports, terminals and convention centres. Wave recycling bins also given an elegant touch to concert halls, museums and exhibition facilities.

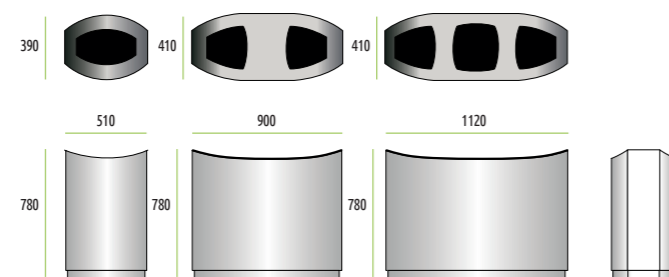

REFERENCES

- Kansas City Airport (USA)
- Minneapolis Royal Golf Club (USA)
- Gallerian Shopping Centre (Sweden)



ORIGINAL DESIGN HENRI SYDÄNHEIMO	DIMENSIONS	CAPACITY	APERTURE	WEIGHT	MATERIAL	THICKNESS
WAVE	510*390*780 mm	100 l, Bag frame for 100-150 l refuse bag	360*200 mm	21 kg	powder-coated galvanised steel and sst EN1.4016	2 mm / 1.25 mm
WAVE DOUBLE	900*410*780 mm	2*100 l, Bag frame for 100-150 l refuse bag	270*260 mm	30 kg	powder-coated galvanised steel and sst EN1.4016	2 mm / 1.25 mm
WAVE TRIPLE	1120*410*780 mm	3*100 l, Bag frame for 100-150 l refuse bag	240*260 mm	41 kg	powder-coated galvanised steel and sst EN1.4016	2 mm / 1.25 mm

STANDARD COLOURS other RAL colours upon request	stainless steel	Finbin Black 1945 (textured)
ACCESSORIES	Stickers with recycling instructions	Rounded lid and sst EN1.4301 for outdoor use

We reserve all rights to changes



COMMITTED TO
HAPPINESS.

FINBIN®

FINBIN products
Lehtovuori Oy
Hopeatie 4
FI-33470 Ylöjärvi, Finland
Tel. +358 3 7846 777
Email: info@lehtovuori.fi
www.finbin.fi



Designed and manufactured in Finland

